



通訊綫路針式絕緣子
PIN INSULATORS FOR TELEPHONE LINES

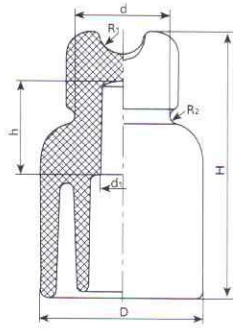

Fig1

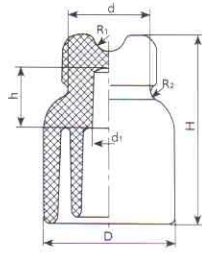

Fig2

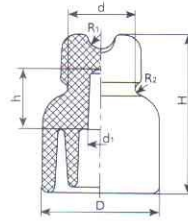

Fig3

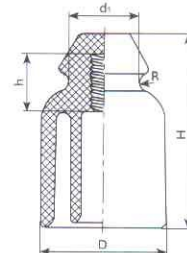

Fig4

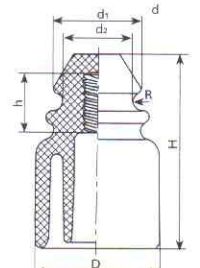

Fig5

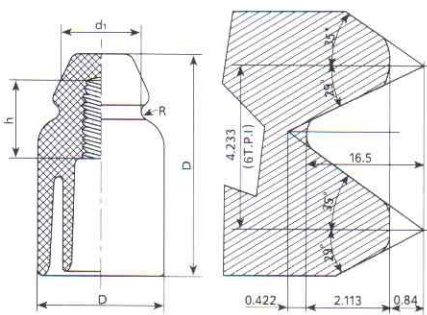

Fig6

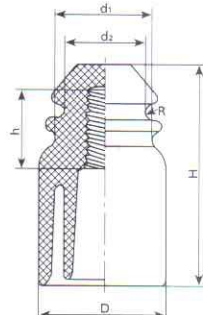

Fig7

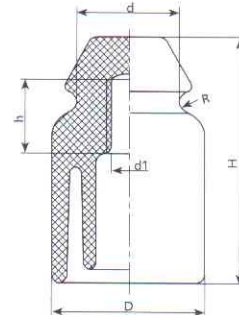

Fig8

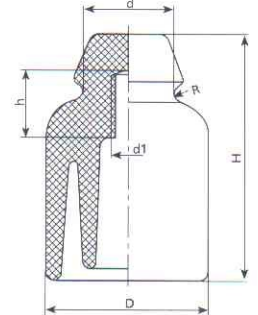

Fig9

主要尺寸和性能 MAIN DIMENSIONS AND STANDARD PARTICULARS

型号 Type	图号 Fig No	主要尺寸(mm/") Main dimensions							绝缘电阻(M) Insulation resistance	抗剪强度(kg.f) Shearing strength	重量(kg) Weight
		H	h	D	d	d1	R1	R2			
RM-1	1	140	49.5	86	51	22.5	12	4	50000		1.1
RM-2	2	100	32	70	44	18.5	8.5	3.5	40000		0.5
RM-3	3	80	30	60	35	13	7	3	20000		0.3
T-4	8	95	31	60	40	13		4	40000	600	0.34
T-5	9	112	31	76	43	16.4		4	50000	800	0.60
No 7	4	119	35	76	44	-		5	10000		0.67
No 1	5	119	35	76	54	44		5	10000		0.62
No 2	6	102	35	60	38	-		5	10000		0.38
No 8	7	102	35	60	44	38		5	10000		0.40



Fuzhou LingT Trading Co., Ltd.

Add: No.1718 A2# Wanda Plaza, Aofeng Road, Fuzhou Fujian China.

Tel: 0086-591-87618322 Fax: 0086-591- 83965269

E-mail: lingt@fjever.com Website: www.fjever.com